

TABLES AND CUPBOARDS

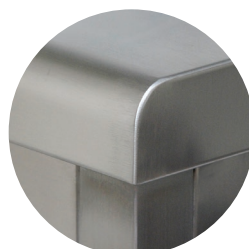

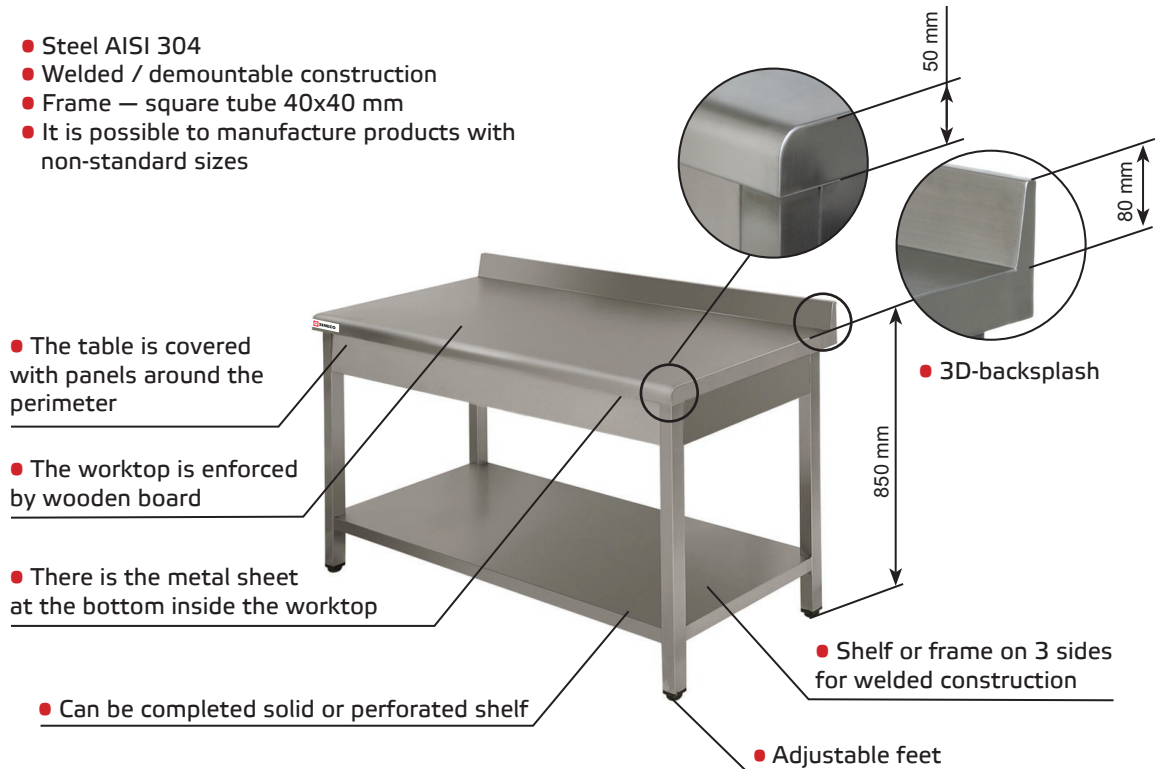

01. WORK TABLES LUX SERIES

- Steel AISI 304
- Welded / demountable construction
- Frame — square tube 40x40 mm
- It is possible to manufacture products with non-standard sizes



Size of product in the package:

Type of construction	Calculation formula, length x depth x height
 *	Length + 10 mm X Depth + 10 mm X 935 mm - for tables with backsplash Length + 10 mm X Depth + 10 mm X 855 mm - for tables without backsplash
	Length + 10 mm X Depth + 10 mm X 280 mm - for tables with backsplash Length + 10 mm X Depth + 10 mm X 200 mm - for tables without backsplash

*LEGEND



welded construction



demountable construction



maximum load



compact packaging



information

WORK TABLE LUX WITH BACKSPLASH

Length, mm	Depth, mm	Welded construction		Demountable construction		Depth, mm	Welded construction		Demountable construction		Note.
		Code	W, kg	Code	W, kg		Code	W, kg	Code	W, kg	
600	600	001.6LS.13935	17,2	001.6LR.13703	20,2	700	001.7LS.00023	19,0	001.7LR.13818	22,1	100 kg
700	600	001.6LS.13936	19,0	001.6LR.13704	22,3	700	001.7LS.14089	21,1	001.7LR.13819	24,5	
800	600	001.6LS.13937	20,9	001.6LR.00091	24,4	700	001.7LS.14090	23,2	001.7LR.13820	26,9	
900	600	001.6LS.00004	22,7	001.6LR.04442	26,6	700	001.7LS.14091	25,3	001.7LR.13821	29,2	
1000	600	001.6LS.00093	24,5	001.6LR.00005	28,7	700	001.7LS.07326	27,4	001.7LR.13822	31,6	
1100	600	001.6LS.13938	26,4	001.6LR.13705	30,8	700	001.7LS.14092	29,4	001.7LR.13823	34,0	
1200	600	001.6LS.04776	28,2	001.6LR.00007	32,9	700	001.7LS.00117	31,5	001.7LR.13824	36,4	
1300	600	001.6LS.13939	30,1	001.6LR.13706	35,0	700	001.7LS.14093	33,6	001.7LR.13825	38,7	
1400	600	001.6LS.00009	31,9	001.6LR.13707	37,2	700	001.7LS.00031	35,7	001.7LR.13826	41,1	
1500	600	001.6LS.13940	33,7	001.6LR.00010	39,3	700	001.7LS.14094	37,8	001.7LR.00120	43,5	
1600	600	001.6LS.13941	35,6	001.6LR.13708	41,4	700	001.7LS.07325	39,9	001.7LR.13827	45,8	80 kg
1700	600	001.6LS.13942	37,4	001.6LR.13709	43,5	700	001.7LS.14095	42,0	001.7LR.13828	48,2	
1800	600	001.6LS.13943	39,2	001.6LR.13710	45,6	700	001.7LS.14096	44,0	001.7LR.13829	50,6	



WORK TABLE LUX WITH BACKSPLASH WITH SHELF



Length, mm	Depth, mm	Welded construction		Demountable construction		Depth, mm	Welded construction		Demountable construction		Note.
		Code	W, kg	Code	W, kg		Code	W, kg	Code	W, kg	
600	600	001.6LS.05420	19,7	001.6LR.01798	24,3	700	001.7LS.14097	21,9	001.7LR.13830	26,8	100 kg
700	600	001.6LS.13944	22,1	001.6LR.13711	27,1	700	001.7LS.00112	24,6	001.7LR.05451	29,9	
800	600	001.6LS.01799	24,4	001.6LR.06464	29,8	700	001.7LS.05580	27,2	001.7LR.00113	32,9	
900	600	001.6LS.01800	26,8	001.6LR.00092	32,6	700	001.7LS.14098	30,0	001.7LR.13831	36,0	
1000	600	001.6LS.01794	29,2	001.6LR.06463	35,3	700	001.7LS.05579	32,6	001.7LR.00115	39,1	
1100	600	001.6LS.00094	31,5	001.6LR.13712	38,0	700	001.7LS.06209	35,3	001.7LR.06671	42,1	
1200	600	001.6LS.04285	33,9	001.6LR.00095	40,8	700	001.7LS.05578	38,0	001.7LR.05454	45,2	
1300	600	001.6LS.06796	36,3	001.6LR.13713	43,5	700	001.7LS.01429	40,7	001.7LR.13832	48,3	
1400	600	001.6LS.06211	38,6	001.6LR.00097	46,3	700	001.7LS.06217	43,4	001.7LR.00119	51,4	
1500	600	001.6LS.01010	41,0	001.6LR.00098	49,0	700	001.7LS.05577	46,1	001.7LR.05586	54,4	
1600	600	001.6LS.00099	43,4	001.6LR.13714	51,8	700	001.7LS.14099	48,8	001.7LR.13833	57,5	80 kg
1700	600	001.6LS.13945	45,7	001.6LR.13715	54,5	700	001.7LS.14100	51,5	001.7LR.13834	60,6	
1800	600	001.6LS.13946	48,1	001.6LR.00101	57,3	700	001.7LS.06210	54,2	001.7LR.00123	63,7	



i It is possible to manufacture **WORK TABLES LUX** series:



- more than 1800 mm long. In this case, to reinforce the welded construction, the tables are with 6 legs;
- it is also possible to produce a table include two under shelves

WORK TABLE LUX WITH BACKSLASH WITH PERFORATED SHELF

Length, mm	Depth, mm	Welded construction		Demountable construction		Depth, mm	Welded construction		Demountable construction		Note
		Code	W, kg	Code	W, kg		Code	W, kg	Code	W, kg	
600	600	001.6LS.13947	19,7	001.6LR.13716	24,3	700	001.7LS.14101	21,8	001.7LR.13835	26,7	 100 kg
700	600	001.6LS.13948	22,0	001.6LR.13717	27,0	700	001.7LS.14102	24,5	001.7LR.13836	29,8	
800	600	001.6LS.13949	24,4	001.6LR.13718	29,8	700	001.7LS.14103	27,2	001.7LR.13837	32,9	
900	600	001.6LS.13950	26,7	001.6LR.13719	32,5	700	001.7LS.14104	29,9	001.7LR.13838	35,9	
1000	600	001.6LS.13951	29,1	001.6LR.13720	35,2	700	001.7LS.14105	32,6	001.7LR.13839	39,0	
1100	600	001.6LS.13952	31,5	001.6LR.13721	38,0	700	001.7LS.14106	35,2	001.7LR.13840	42,0	
1200	600	001.6LS.13953	33,8	001.6LR.13722	40,7	700	001.7LS.14107	37,9	001.7LR.13841	45,1	
1300	600	001.6LS.13954	36,2	001.6LR.13723	43,4	700	001.7LS.14108	40,6	001.7LR.13842	48,2	
1400	600	001.6LS.13955	38,5	001.6LR.13724	46,2	700	001.7LS.14109	43,3	001.7LR.13843	51,2	
1500	600	001.6LS.13956	40,9	001.6LR.13725	48,9	700	001.7LS.14110	46,0	001.7LR.13844	54,3	
1600	600	001.6LS.13957	43,3	001.6LR.13726	51,7	700	001.7LS.14111	48,7	001.7LR.13845	57,4	 80 kg
1700	600	001.6LS.13958	45,6	001.6LR.13727	54,4	700	001.7LS.14112	51,4	001.7LR.13846	60,4	
1800	600	001.6LS.13959	48,0	001.6LR.13728	57,1	700	001.7LS.14113	54,0	001.7LR.13847	63,5	



WORK TABLE LUX WITHOUT BACKSLASH

Length, mm	Depth, mm	Welded construction		Demountable construction		Depth, mm	Welded construction		Demountable construction		Note
		Code	W, kg	Code	W, kg		Code	W, kg	Code	W, kg	
600	600	001.6LS.13899	16,5	001.6LR.13666	19,6	700	001.7LS.14053	18,4	001.7LR.00286	21,5	 100 kg
700	600	001.6LS.13900	18,3	001.6LR.13667	21,6	700	001.7LS.14054	20,4	001.7LR.13780	23,7	
800	600	001.6LS.13901	20,0	001.6LR.13668	23,6	700	001.7LS.14055	22,3	001.7LR.13781	26,0	
900	600	001.6LS.13902	21,7	001.6LR.13669	25,6	700	001.7LS.14056	24,3	001.7LR.13782	28,2	
1000	600	001.6LS.13903	23,4	001.6LR.07302	27,6	700	001.7LS.14057	26,2	001.7LR.13783	30,5	
1100	600	001.6LS.13904	25,1	001.6LR.13670	29,6	700	001.7LS.14058	28,2	001.7LR.13784	32,8	
1200	600	001.6LS.13905	26,8	001.6LR.00270	31,6	700	001.7LS.14059	30,2	001.7LR.13785	35,0	
1300	600	001.6LS.13906	28,6	001.6LR.13671	33,6	700	001.7LS.14060	32,1	001.7LR.13786	37,3	
1400	600	001.6LS.13907	30,3	001.6LR.13672	35,6	700	001.7LS.14061	34,1	001.7LR.13787	39,5	
1500	600	001.6LS.13908	32,0	001.6LR.13673	37,6	700	001.7LS.14062	36,1	001.7LR.13788	41,8	
1600	600	001.6LS.13909	33,7	001.6LR.13674	39,6	700	001.7LS.14063	38,1	001.7LR.13789	44,0	 80 kg
1700	600	001.6LS.13910	35,4	001.6LR.13675	41,6	700	001.7LS.14064	40,0	001.7LR.13790	46,3	
1800	600	001.6LS.13911	37,1	001.6LR.13676	43,6	700	001.7LS.14065	41,9	001.7LR.13791	48,5	



WORK TABLE LUX WITHOUT BACKSPASH WITH SHELF

Length, mm	Depth, mm	Welded construction		Demountable construction		Depth, mm	Welded construction		Demountable construction		Note
		Code	W, kg	Code	W, kg		Code	W, kg	Code	W, kg	
600	600	001.6LS.13912	19,2	001.6LR.13677	23,9	700	001.7LS.14066	21,3	001.7LR.13792	26,3	 100 kg
700	600	001.6LS.13913	21,4	001.6LR.13678	26,5	700	001.7LS.14067	23,9	001.7LR.13793	29,3	
800	600	001.6LS.06799	23,7	001.6LR.13679	29,2	700	001.7LS.06758	26,5	001.7LR.13794	32,3	
900	600	001.6LS.13914	26,0	001.6LR.13680	31,8	700	001.7LS.14068	29,1	001.7LR.13795	35,3	
1000	600	001.6LS.06218	28,2	001.6LR.13681	34,5	700	001.7LS.00378	31,7	001.7LR.13796	38,3	
1100	600	001.6LS.13915	30,5	001.6LR.13682	37,1	700	001.7LS.00379	34,3	001.7LR.13797	41,2	
1200	600	001.6LS.13916	32,8	001.6LR.13683	39,8	700	001.7LS.14069	36,9	001.7LR.13798	44,2	
1300	600	001.6LS.13917	35,1	001.6LR.13684	42,4	700	001.7LS.14070	39,5	001.7LR.3799	47,2	
1400	600	001.6LS.00360	37,3	001.6LR.13685	45,1	700	001.7LS.14071	42,1	001.7LR.13800	50,2	
1500	600	001.6LS.13918	39,6	001.6LR.13686	47,8	700	001.7LS.14072	44,7	001.7LR.13801	53,2	
1600	600	001.6LS.13919	41,9	001.6LR.13687	50,4	700	001.7LS.14073	47,3	001.7LR.13802	56,2	
1700	600	001.6LS.13920	44,1	001.6LR.13688	53,1	700	001.7LS.14074	49,9	001.7LR.13803	59,1	
1800	600	001.6LS.13921	46,4	001.6LR.13689	55,7	700	001.7LS.14075	52,5	001.7LR.13804	62,1	



WORK TABLE LUX WITHOUT BACKSPASH WITH PERFORATED SHELF

Length, mm	Depth, mm	Welded construction		Demountable construction		Depth, mm	Welded construction		Demountable construction		Note
		Code	W, kg	Code	W, kg		Code	W, kg	Code	W, kg	
600	600	001.6LS.13922	19,1	001.6LR.13690	23,8	700	001.7LS.14076	21,3	001.7LR.13805	26,3	 100 kg
700	600	001.6LS.13923	21,4	001.6LR.13691	26,5	700	001.7LS.14077	23,8	001.7LR.13806	29,3	
800	600	001.6LS.13924	23,6	001.6LR.13692	29,1	700	001.7LS.14078	26,4	001.7LR.13807	32,2	
900	600	001.6LS.13925	25,9	001.6LR.13693	31,8	700	001.7LS.14079	29,0	001.7LR.13808	35,2	
1000	600	001.6LS.13926	28,2	001.6LR.13694	34,4	700	001.7LS.14080	31,6	001.7LR.13809	38,2	
1100	600	001.6LS.13927	30,4	001.6LR.13695	37,1	700	001.7LS.14081	34,2	001.7LR.13810	41,1	
1200	600	001.6LS.13928	32,7	001.6LR.13696	39,7	700	001.7LS.14082	36,8	001.7LR.13811	44,1	
1300	600	001.6LS.13929	35,0	001.6LR.13697	42,3	700	001.7LS.14083	39,4	001.7LR.13812	47,1	
1400	600	001.6LS.13930	37,2	001.6LR.13698	45,0	700	001.7LS.14084	42,0	001.7LR.13813	50,1	
1500	600	001.6LS.13931	39,5	001.6LR.13699	47,6	700	001.7LS.14085	44,6	001.7LR.13814	53,0	
1600	600	001.6LS.13932	41,8	001.6LR.13700	50,3	700	001.7LS.14086	47,2	001.7LR.13815	56,0	
1700	600	001.6LS.13933	44,0	001.6LR.13701	52,9	700	001.7LS.14087	49,8	001.7LR.13816	59,0	
1800	600	001.6LS.13934	46,3	001.6LR.13702	55,6	700	001.7LS.14088	52,3	001.7LR.13817	61,9	



01. WORK TABLES UNIVERSAL SERIES

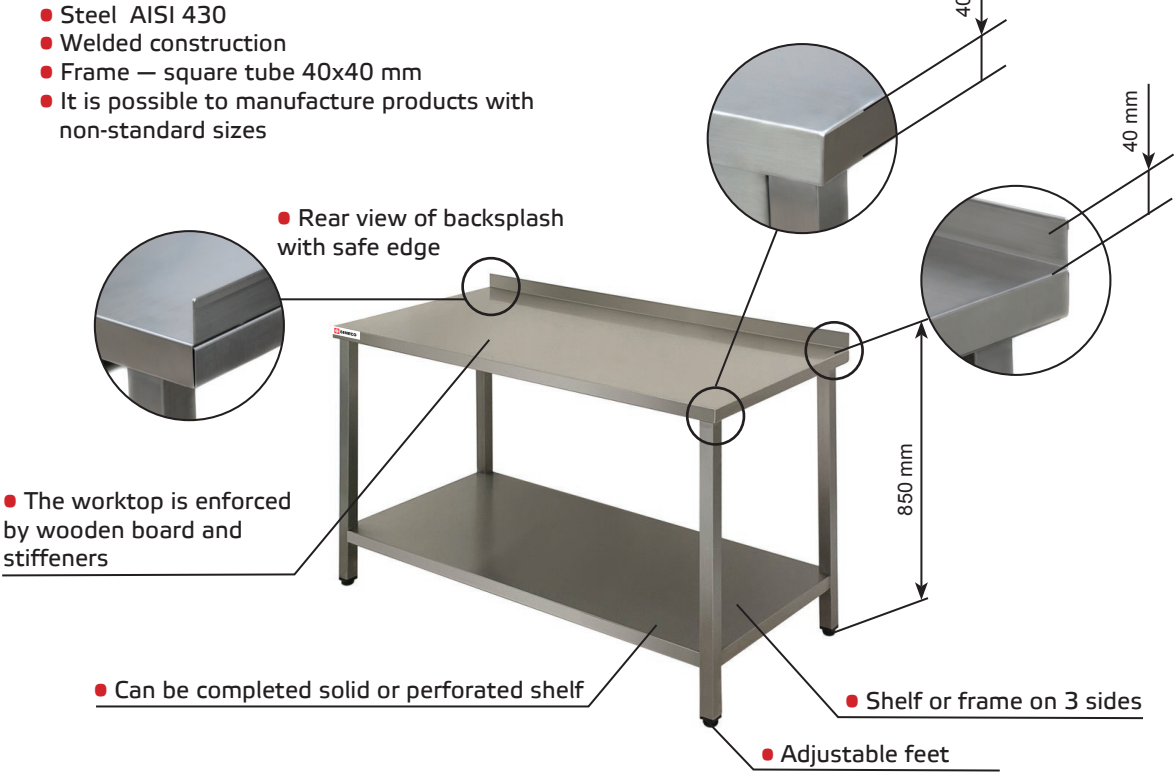

Size of product in the package:



Type of construction	Calculation formula, length x depth x height
	Length + 10 mm X Depth + 10 mm X 895 mm - for tables with backsplash Length + 10 mm X Depth + 10 mm X 855 mm - for tables without backsplash

WORK TABLE UNIVERSAL WITH BACKSPLASH

Length, mm	Depth, mm	Welded construction		Depth, mm	Welded construction.		Note	
		Code	W, kg		Code	W, kg		
600	600	001.6US.14029	13,5	700	001.7US.14189	14,8	 100 kg	
700	600	001.6US.14030	14,8	700	001.7US.14190	16,4		
800	600	001.6US.06927	16,2	700	001.7US.07443	17,9		
900	600	001.6US.14031	17,5	700	001.7US.14191	19,5		
1000	600	001.6US.06643	18,8	700	001.7US.07452	21,0		
1100	600	001.6US.06569	20,2	700	001.7US.14192	22,6		
1200	600	001.6US.14032	21,6	700	001.7US.07453	24,1		
1300	600	001.6US.14033	22,9	700	001.7US.14193	25,7		
1400	600	001.6US.06570	24,3	700	001.7US.14194	27,2		
1500	600	001.6US.14034	25,6	700	001.7US.04962	28,8		
1600	600	001.6US.14035	27,0	700	001.7US.14195	30,3		 80 kg
1700	600	001.6US.14036	28,3	700	001.7US.14196	31,9		
1800	600	001.6US.14037	29,7	700	001.7US.14197	33,4		



WORK TABLE UNIVERSAL WITH BACKSPLASH WITH SHELF

Length, mm	Depth, mm	Welded construction		Depth, mm	Welded construction.		Note	
		Code	W, kg		Code	W, kg		
600	600	001.6US.04702	16,0	700	001.7US.05568	26,3	 100 kg	
700	600	001.6US.06929	17,9	700	001.7US.04603	28,4		
800	600	001.6US.04593	19,7	700	001.7US.06146	30,6		
900	600	001.6US.06279	21,6	700	001.7US.06575	32,7		
1000	600	001.6US.04601	23,5	700	001.7US.04812	34,9		
1100	600	001.6US.06442	25,4	700	001.7US.05327	37,0		
1200	600	001.6US.04587	27,3	700	001.7US.04588	39,2		
1300	600	001.6US.01306	29,1	700	001.7US.06571	41,3		
1400	600	001.6US.05046	31,0	700	001.7US.06644	43,5		
1500	600	001.6US.04589	32,9	700	001.7US.04591	17,7		
1600	600	001.6US.06458	34,8	700	001.7US.14198	19,8		 80 kg
1700	600	001.6US.14038	36,7	700	001.7US.14199	22,0		
1800	600	001.6US.14039	38,5	700	001.7US.07060	24,1		



- i**
- It is possible to manufacture **WORK TABLES UNIVERSAL** series:
- more than 1800 mm long.
The tables are with 6 legs;
 - it is also possible to produce a table include two under shelves



WORK TABLE UNIVERSAL WITH BACKSPLASH WITH PERFORATED SHELF



Length, mm	Depth, mm	Welded construction		Depth, mm	Welded construction		Note
		Code	W, kg		Code	W, kg	
600	600	001.6US.14040	15,9	700	001.7US.14200	17,6	 100 kg
700	600	001.6US.14041	17,8	700	001.7US.14201	19,8	
800	600	001.6US.14042	19,7	700	001.7US.04594	21,9	
900	600	001.6US.14043	21,6	700	001.7US.14202	24,0	
1000	600	001.6US.14044	23,4	700	001.7US.14203	26,2	
1100	600	001.6US.14045	25,3	700	001.7US.14204	28,3	
1200	600	001.6US.14046	27,2	700	001.7US.14205	30,5	
1300	600	001.6US.14047	29,1	700	001.7US.14206	32,6	
1400	600	001.6US.14048	31,0	700	001.7US.14207	34,7	
1500	600	001.6US.14049	32,8	700	001.7US.14208	36,9	
1600	600	001.6US.14050	34,7	700	001.7US.14209	39,0	
1700	600	001.6US.14051	36,6	700	001.7US.14210	41,1	
1800	600	001.6US.14052	38,5	700	001.7US.14211	43,3	

WORK TABLE UNIVERSAL WITHOUT BACKSPLASH





Length, mm	Depth, mm	Welded construction		Depth, mm	Welded construction		Note
		Code	W, kg		Code	W, kg	
600	600	001.6US.13994	13,2	700	001.7US.14158	14,5	 100 kg
700	600	001.6US.13995	14,5	700	001.7US.14159	16,1	
800	600	001.6US.06441	15,9	700	001.7US.06277	17,6	
900	600	001.6US.13996	17,2	700	001.7US.14160	19,1	
1000	600	001.6US.13997	18,6	700	001.7US.14161	20,6	
1100	600	001.6US.13998	19,9	700	001.7US.14162	22,1	
1200	600	001.6US.13999	21,2	700	001.7US.14163	23,6	
1300	600	001.6US.07259	22,6	700	001.7US.04847	25,1	
1400	600	001.6US.14001	23,9	700	001.7US.04598	26,6	
1500	600	001.6US.14002	25,3	700	001.7US.14164	28,1	
1600	600	001.6US.14003	26,6	700	001.7US.14165	29,6	
1700	600	001.6US.14004	27,9	700	001.7US.14166	31,2	
1800	600	001.6US.14005	29,3	700	001.7US.07059	32,7	

WORK TABLE UNIVERSAL WITHOUT BACKSPASH WITH SHELF

Length, mm	Depth, mm	Welded construction		Depth, mm	Welded construction		Note	
		Code	W, kg		Code	W, kg		
600	600	001.6US.14006	15,9	700	001.7US.05215	17,5	 100 kg	
700	600	001.6US.14007	17,7	700	001.7US.06662	19,7		
800	600	001.6US.05862	19,6	700	001.7US.14167	21,8		
900	600	001.6US.06461	21,5	700	001.7US.04873	24,0		
1000	600	001.6US.14009	23,4	700	001.7US.14169	26,1		
1100	600	001.6US.14010	25,3	700	001.7US.14170	28,3		
1200	600	001.6US.04711	27,2	700	001.7US.14171	30,4		
1300	600	001.6US.14011	29,1	700	001.7US.06576	32,6		
1400	600	001.6US.14012	31,0	700	001.7US.07260	34,7		
1500	600	001.6US.06462	32,9	700	001.7US.14173	36,9		
1600	600	001.6US.14013	34,8	700	001.7US.14174	39,0		 80 kg
1700	600	001.6US.14014	36,6	700	001.7US.14175	41,2		
1800	600	001.6US.14015	38,5	700	001.7US.07454	43,3		



WORK TABLE UNIVERSAL WITHOUT BACKSPASH WITH PERFORATED SHELF

Length, mm	Depth, mm	Welded construction		Depth, mm	Welded construction		Note	
		Code	W, kg		Code	W, kg		
600	600	001.6US.14016	15,8	700	001.7US.14176	17,5	 100 kg	
700	600	001.6US.14017	17,7	700	001.7US.14177	19,6		
800	600	001.6US.14018	19,6	700	001.7US.14178	21,7		
900	600	001.6US.14019	21,4	700	001.7US.14179	23,9		
1000	600	001.6US.14020	23,3	700	001.7US.14180	26,0		
1100	600	001.6US.14021	25,2	700	001.7US.14181	28,2		
1200	600	001.6US.14022	27,1	700	001.7US.14182	30,3		
1300	600	001.6US.14023	29,0	700	001.7US.14183	32,4		
1400	600	001.6US.14024	30,8	700	001.7US.14184	34,6		
1500	600	001.6US.14025	32,7	700	001.7US.14185	36,7		
1600	600	001.6US.14026	34,6	700	001.7US.14186	38,9		 80 kg
1700	600	001.6US.14027	36,5	700	001.7US.14187	41,0		
1800	600	001.6US.14028	38,4	700	001.7US.14188	43,1		





01. WORK TABLES BUSINESS SERIES

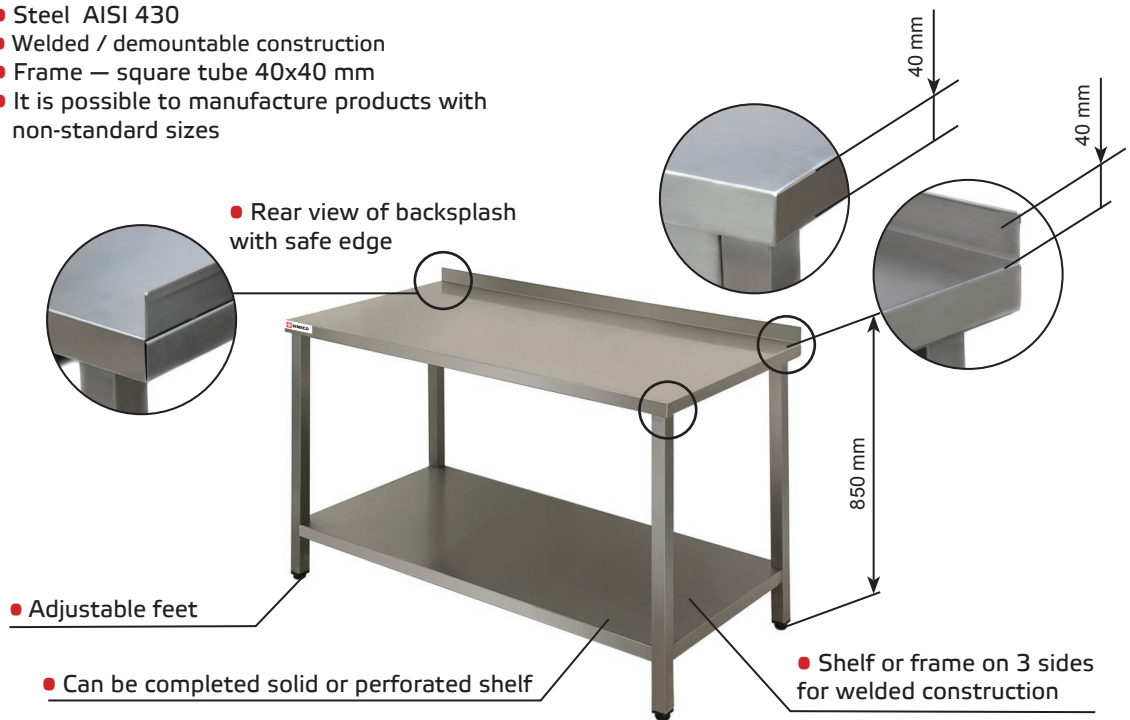

- Steel AISI 430
- Welded / demountable construction
- Frame — square tube 40x40 mm
- It is possible to manufacture products with non-standard sizes



Size of product in the package:



Type of construction	Calculation formula, length x depth x height
	Length + 10 mm X Depth + 10 mm X 895 mm - for tables with backsplash Length + 10 mm X Depth + 10 mm X 855 mm - for tables without backsplash
	Length + 10 mm X Depth + 10 mm X 195 mm - for tables with backsplash Length + 10 mm X Depth + 10 mm X 150 mm - for tables without backsplash

WORK TABLE BUSINESS WITH BACKSPASH

Length, mm	Depth, mm	Welded construction		Demountable construction		Depth, mm	Welded construction		Demountable construction		Note
		Code	W, kg	Code	W, kg		Code	W, kg	Code	W, kg	
600	600	001.6ES.06873	10,0	001.6ER.00045	13,3	700	001.7ES.07268	10,8	001.7ER.13877	14,2	 100 kg
700	600	001.6ES.01913	10,8	001.6ER.13757	14,3	700	001.7ES.14138	11,7	001.7ER.13878	15,2	
800	600	001.6ES.05703	11,6	001.6ER.00047	15,2	700	001.7ES.04239	12,5	001.7ER.13879	16,2	
900	600	001.6ES.04443	12,3	001.6ER.00048	16,1	700	001.7ES.14139	13,3	001.7ER.06053	17,2	
1000	600	001.6ES.06855	13,1	001.6ER.13758	17,1	700	001.7ES.05376	14,2	001.7ER.04255	18,3	
1100	600	001.6ES.06266	13,9	001.6ER.13759	18,0	700	001.7ES.07344	15,0	001.7ER.13880	19,3	
1200	600	001.6ES.04444	14,7	001.6ER.00051	19,0	700	001.7ES.01630	15,9	001.7ER.02095	20,3	
1300	600	001.6ES.04717	15,4	001.6ER.13760	19,9	700	001.7ES.14140	16,7	001.7ER.13881	21,4	
1400	600	001.6ES.06108	16,2	001.6ER.02040	20,9	700	001.7ES.14141	17,5	001.7ER.13882	22,4	
1500	600	001.6ES.06902	17,0	001.6ER.00054	21,8	700	001.7ES.14142	18,4	001.7ER.13883	23,4	
1600	600	001.6ES.00055	17,7	001.6ER.13761	22,8	700	001.7ES.14143	19,2	001.7ER.02094	24,4	 80 kg
1700	600	001.6ES.13982	18,5	001.6ER.13762	23,7	700	001.7ES.01635	20,1	001.7ER.13884	25,5	
1800	600	001.6ES.00057	19,3	001.6ER.13763	24,7	700	001.7ES.06101	20,9	001.7ER.00079	26,5	





WORK TABLE BUSINESS WITH BACKSPASH WITH SHELF

Length, mm	Depth, mm	Welded construction		Demountable construction		Depth, mm	Welded construction		Demountable construction		Note
		Code	W, kg	Code	W, kg		Code	W, kg	Code	W, kg	
600	600	001.6ES.04829	12,5	001.6ER.04840	17,4	700	001.7ES.01705	13,6	001.7ER.05840	18,8	 100 kg
700	600	001.6ES.04456	13,8	001.6ER.04454	19,0	700	001.7ES.04728	15,1	001.7ER.05631	20,5	
800	600	001.6ES.01698	15,1	001.6ER.05240	20,6	700	001.7ES.04738	16,5	001.7ER.06701	22,3	
900	600	001.6ES.04234	16,4	001.6ER.04839	22,2	700	001.7ES.01633	18,0	001.7ER.06702	24,0	
1000	600	001.6ES.04332	17,7	001.6ER.01778	23,7	700	001.7ES.05233	19,4	001.7ER.00159	25,7	
1100	600	001.6ES.02042	19,0	001.6ER.00138	25,3	700	001.7ES.05235	20,9	001.7ER.13885	27,5	
1200	600	001.6ES.01645	20,3	001.6ER.00139	26,9	700	001.7ES.01996	22,3	001.7ER.05358	29,2	
1300	600	001.6ES.06805	21,6	001.6ER.00140	28,4	700	001.7ES.04214	23,8	001.7ER.07528	30,9	
1400	600	001.6ES.05882	22,9	001.6ER.06779	30,0	700	001.7ES.04281	25,2	001.7ER.05238	32,7	
1500	600	001.6ES.02001	24,2	001.6ER.00142	31,6	700	001.7ES.04218	26,7	001.7ER.06704	34,4	
1600	600	001.6ES.05393	25,5	001.6ER.13764	33,2	700	001.7ES.06920	28,1	001.7ER.00165	36,1	 80 kg
1700	600	001.6ES.04658	26,8	001.6ER.13765	34,7	700	001.7ES.14144	29,6	001.7ER.02003	37,8	
1800	600	001.6ES.04736	28,1	001.6ER.13766	36,3	700	001.7ES.05054	31,0	001.7ER.00167	39,6	





WORK TABLE BUSINESS WITH BACKSPLASH WITH PERFORATED SHELF

Length, mm	Depth, mm	Welded construction		Demountable construction		Depth, mm	Welded construction		Demountable construction		Note
		Code	W, kg	Code	W, kg		Code	W, kg	Code	W, kg	
600	600	001.6ES.04138	12,5	001.6ER.13767	17,4	700	001.7ES.14145	13,7	001.7ER.13886	18,8	 100 kg
700	600	001.6ES.13983	13,8	001.6ER.13768	19,0	700	001.7ES.14146	15,1	001.7ER.13887	20,5	
800	600	001.6ES.13984	15,1	001.6ER.13769	20,5	700	001.7ES.14147	16,6	001.7ER.13888	22,2	
900	600	001.6ES.06707	16,4	001.6ER.13770	22,1	700	001.7ES.14148	18,0	001.7ER.13889	23,9	
1000	600	001.6ES.13985	17,7	001.6ER.13771	23,7	700	001.7ES.14149	19,5	001.7ER.13890	25,6	
1100	600	001.6ES.13986	18,9	001.6ER.13772	25,3	700	001.7ES.14150	20,9	001.7ER.13891	27,4	
1200	600	001.6ES.13987	20,2	001.6ER.13773	26,8	700	001.7ES.14151	22,4	001.7ER.13892	29,1	
1300	600	001.6ES.13988	21,5	001.6ER.13774	28,4	700	001.7ES.14152	23,8	001.7ER.13893	30,8	
1400	600	001.6ES.13989	22,8	001.6ER.13775	30,0	700	001.7ES.14153	25,3	001.7ER.13894	32,5	
1500	600	001.6ES.13990	24,1	001.6ER.13776	31,6	700	001.7ES.14154	26,7	001.7ER.13895	34,2	
1600	600	001.6ES.13991	25,4	001.6ER.13777	33,1	700	001.7ES.14155	28,2	001.7ER.13896	36,0	 80 kg
1700	600	001.6ES.13992	26,7	001.6ER.13778	34,7	700	001.7ES.14156	29,6	001.7ER.13897	37,7	
1800	600	001.6ES.13993	28,0	001.6ER.13779	36,3	700	001.7ES.14157	31,1	001.7ER.13898	39,4	





WORK TABLE BUSINESS WITHOUT BACKSPLASH

Length, mm	Depth, mm	Welded construction		Demountable construction		Depth, mm	Welded construction		Demountable construction		Note
		Code	W, kg	Code	W, kg		Code	W, kg	Code	W, kg	
600	600	001.6ES.06850	10,1	001.6ER.13729	13,5	700	001.7ES.07487	10,9	001.7ER.13848	14,3	 100 kg
700	600	001.6ES.13960	10,9	001.6ER.13730	14,4	700	001.7ES.04233	11,8	001.7ER.00331	15,4	
800	600	001.6ES.13961	11,7	001.6ER.13731	15,4	700	001.7ES.14114	12,6	001.7ER.13849	16,4	
900	600	001.6ES.00311	12,4	001.6ER.13732	16,3	700	001.7ES.06267	13,5	001.7ER.06054	17,4	
1000	600	001.6ES.13962	13,2	001.6ER.13733	17,3	700	001.7ES.06127	14,4	001.7ER.13850	18,5	
1100	600	001.6ES.13963	14,0	001.6ER.13734	18,3	700	001.7ES.14115	15,2	001.7ER.13851	19,5	
1200	600	001.6ES.04654	14,7	001.6ER.13735	19,2	700	001.7ES.05896	16,1	001.7ER.00336	20,5	
1300	600	001.6ES.13964	15,5	001.6ER.13736	20,2	700	001.7ES.14116	16,9	001.7ER.13852	21,6	
1400	600	001.6ES.06164	16,3	001.6ER.13737	21,1	700	001.7ES.14117	17,8	001.7ER.13853	22,6	
1500	600	001.6ES.00317	17,1	001.6ER.13738	22,1	700	001.7ES.14118	18,7	001.7ER.05359	23,7	
1600	600	001.6ES.06112	17,8	001.6ER.13739	23,0	700	001.7ES.14119	19,5	001.7ER.06254	24,7	 80 kg
1700	600	001.6ES.13965	18,6	001.6ER.13740	24,0	700	001.7ES.14120	20,4	001.7ER.13854	25,7	
1800	600	001.6ES.13966	19,4	001.6ER.05357	25,0	700	001.7ES.14121	21,2	001.7ER.13855	26,8	



WORK TABLE BUSINESS WITHOUT BACKSPLASH WITH SHELF



Length, mm	Depth, mm	Welded construction		Demountable construction		Depth, mm	Welded construction		Demountable construction		Note
		Code	W, kg	Code	W, kg		Code	W, kg	Code	W, kg	
600	600	001.6ES.16050	12,8	001.6ER.05210	17,8	700	001.7ES.05236	13,9	001.7ER.04362	19,2	 100 kg
700	600	001.6ES.06500	14,1	001.6ER.04171	19,4	700	001.7ES.14122	15,4	001.7ER.13856	20,9	
800	600	001.6ES.06191	15,4	001.6ER.02093	21,0	700	001.7ES.06711	16,9	001.7ER.13857	22,7	
900	600	001.6ES.04235	16,8	001.6ER.05630	22,6	700	001.7ES.05058	18,4	001.7ER.06862	24,5	
1000	600	001.6ES.04324	18,1	001.6ER.01724	24,2	700	001.7ES.05234	19,9	001.7ER.13858	26,2	
1100	600	001.6ES.13967	19,4	001.6ER.13741	25,8	700	001.7ES.14123	21,4	001.7ER.01629	28,0	
1200	600	001.6ES.04322	20,8	001.6ER.00402	27,4	700	001.7ES.05055	22,9	001.7ER.00424	29,8	
1300	600	001.6ES.02011	22,1	001.6ER.13742	29,0	700	001.7ES.14124	24,4	001.7ER.13859	31,5	
1400	600	001.6ES.02012	23,4	001.6ER.00404	30,7	700	001.7ES.05064	25,9	001.7ER.13860	33,3	
1500	600	001.6ES.04323	24,7	001.6ER.06824	32,3	700	001.7ES.05056	27,4	001.7ER.13861	35,1	
1600	600	001.6ES.13968	26,1	001.6ER.05973	33,9	700	001.7ES.04780	28,9	001.7ER.00428	36,8	 80 kg
1700	600	001.6ES.06087	27,4	001.6ER.13743	35,5	700	001.7ES.00429	30,4	001.7ER.13862	38,6	
1800	600	001.6ES.04890	28,7	001.6ER.13744	37,1	700	001.7ES.05057	31,9	001.7ER.13863	40,4	



It is possible to manufacture **WORK TABLES BUSINESS** series

- more than 1800 mm long. In this case, to reinforce the welded construction, the tables are with 6 legs;
- it is also possible to produce a table include two under shelves

WORK TABLE BUSINESS WITHOUT BACKSPLASH WITH PERFORATED SHELF

Length, mm	Depth, mm	Welded construction		Demountable construction		Depth, mm	Welded construction		Demountable construction		Note
		Code	W, kg	Code	W, kg		Code	W, kg	Code	W, kg	
600	600	001.6ES.13969	12,7	001.6ER.04983	17,7	700	001.7ES.14125	13,9	001.7ER.13864	26,1	 100 kg
700	600	001.6ES.13970	14,0	001.6ER.13745	19,3	700	001.7ES.14126	15,4	001.7ER.13865	27,9	
800	600	001.6ES.13971	15,4	001.6ER.13746	20,9	700	001.7ES.14127	16,9	001.7ER.13866	29,7	
900	600	001.6ES.13972	16,7	001.6ER.13747	22,5	700	001.7ES.14128	18,3	001.7ER.13867	31,4	
1000	600	001.6ES.13973	18,0	001.6ER.13748	24,1	700	001.7ES.14129	19,8	001.7ER.13868	33,2	
1100	600	001.6ES.13974	19,3	001.6ER.13749	25,7	700	001.7ES.14130	21,3	001.7ER.13869	34,9	
1200	600	001.6ES.13975	20,7	001.6ER.13750	27,3	700	001.7ES.14131	22,8	001.7ER.13870	36,7	
1300	600	001.6ES.13976	22,0	001.6ER.13751	29,0	700	001.7ES.14132	24,3	001.7ER.13871	38,4	
1400	600	001.6ES.13977	23,3	001.6ER.13752	30,6	700	001.7ES.14133	25,8	001.7ER.13872	40,2	
1500	600	001.6ES.13978	24,6	001.6ER.13753	32,2	700	001.7ES.14134	27,3	001.7ER.13873	19,1	
1600	600	001.6ES.13979	26,0	001.6ER.13754	33,8	700	001.7ES.14135	28,7	001.7ER.13874	20,9	 80 kg
1700	600	001.6ES.13980	27,3	001.6ER.13755	35,4	700	001.7ES.14136	30,2	001.7ER.13875	22,6	
1800	600	001.6ES.13981	28,6	001.6ER.13756	37,0	700	001.7ES.14137	31,7	001.7ER.13876	24,4	



03. TABLES WITH WASTE DISPOSAL HOLE LUX SERIES

- Steel AISI 304
- Welded / demountable construction
- Frame — square tube 40x40 mm
- Can be completed solid or perforated shelf
- It is possible to manufacture products with non-standard sizes

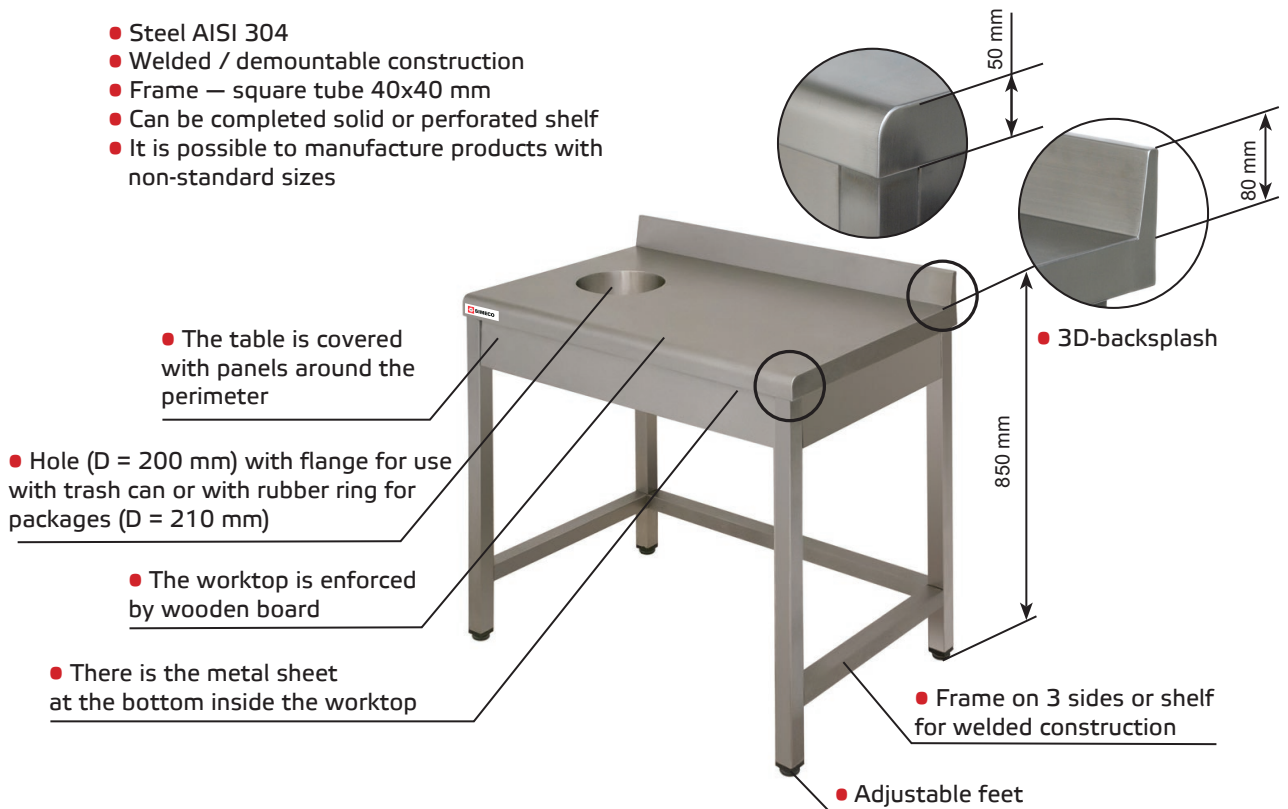

Size of product in the package:



Type of construction	Calculation formula, length x depth x height
	Length + 10 mm X Depth + 10 mm X 935 mm - for tables with backsplash Length + 10 mm X Depth + 10 mm X 855 mm - for tables without backsplash
	Length + 10 mm X Depth + 10 mm X 280 mm - for tables with backsplash Length + 10 mm X Depth + 10 mm X 150 mm - for tables without backsplash

TABLE WITH WASTE DISPOSAL HOLE LUX WITH BACKSPLASH

Length, mm	Depth, mm	Welded construction		Demountable constr.		Depth, mm	Welded construction		Demountable constr.	
		Code	W, kg	Code	W, kg		Code	W, kg	Code	W, kg
TABLE WITH WASTE DISPOSAL HOLE LUX WITH BACKSPLASH (CENTRAL HOLE)										
600	600	003.6LS.04446	17,1	003.6LR.15544	20,1	700	003.7LS.15722	18,9	003.7LR.15592	22,0
700	600	003.6LS.15641	18,9	003.6LR.15545	22,2	700	003.7LS.15723	21,0	003.7LR.15593	24,4
800	600	003.6LS.15642	20,8	003.6LR.15546	24,3	700	003.7LS.15724	23,1	003.7LR.15594	26,8

Central hole
The panels are 100 mm high



The panels are 140 mm high



Left / right hole

Length, mm	Depth, mm	Welded construction		Demountable construction			
		Code	W, kg	Code	W, kg		
TABLE WITH WASTE DISPOSAL HOLE LUX WITH BACKSPLASH (LEFT/RIGHT HOLE)							
		левое, L	правое, R	левое, L	правое, R		
900	600	003.6LS.15643	003.6LS.15650	22,6	003.6LR.04160	003.6LR.15553	26,5
1000	600	003.6LS.15644	003.6LS.15651	24,4	003.6LR.15547	003.6LR.15554	28,6
1100	600	003.6LS.15645	003.6LS.15652	26,3	003.6LR.15548	003.6LR.15555	30,7
1200	600	003.6LS.15646	003.6LS.04764	28,1	003.6LR.15549	003.6LR.15556	32,8
1300	600	003.6LS.15647	003.6LS.15653	30,0	003.6LR.15550	003.6LR.15557	34,9
1400	600	003.6LS.15648	003.6LS.15654	31,8	003.6LR.15551	003.6LR.15558	37,1
1500	600	003.6LS.15649	003.6LS.15655	33,6	003.6LR.15552	003.6LR.15559	39,2
900	700	003.7LS.15725	003.7LS.25103	25,2	003.7LR.15595	003.7LR.15601	29,1
1000	700	003.7LS.15726	003.7LS.15733	27,3	003.7LR.15596	003.7LR.15602	31,5
1100	700	003.7LS.15727	003.7LS.15734	29,3	003.7LR.15597	003.7LR.15603	33,9
1200	700	003.7LS.15728	003.7LS.15735	31,4	003.7LR.15598	003.7LR.15604	36,3
1300	700	003.7LS.15729	003.7LS.15736	33,5	003.7LR.15599	003.7LR.15605	38,6
1400	700	003.7LS.15730	003.7LS.15737	35,6	003.7LR.15600	003.7LR.15606	41,0
1500	700	003.7LS.15731	003.7LS.15738	37,7	003.7LR.05452	003.7LR.15607	43,4

TABLE WITH WASTE DISPOSAL HOLE LUX WITHOUT BACKSPLASH

Length, mm	Depth, mm	Welded construction		Demountable constr.		Depth, mm	Welded construction		Demountable constr.	
		Code	W, kg	Code	W, kg		Code	W, kg	Code	W, kg
TABLE WITH WASTE DISPOSAL HOLE LUX WITHOUT BACKSPLASH (CENTRAL HOLE)										
600	600	003.6LS.15624	16,4	003.6LR.15527	19,5	700	003.7LS.15705	18,3	003.7LR.15575	21,4
700	600	003.6LS.15625	18,2	003.6LR.15528	21,5	700	003.7LS.15706	20,2	003.7LR.15576	23,6
800	600	003.6LS.15626	19,9	003.6LR.15529	23,5	700	003.7LS.15707	22,2	003.7LR.15577	25,9

It is possible to manufacture tables with waste disposal hole more than 1800 mm long.

Central hole



Left / right hole

Length, mm	Depth, mm	Welded construction		Demountable construction			
		Code	W, kg	Code	W, kg		
TABLE WITH WASTE DISPOSAL HOLE LUX WITHOUT BACKSPLASH (LEFT/RIGHT HOLE)							
		левое, L	правое, R	левое, L	правое, R		
900	600	003.6LS.15627	003.6LS.15634	21,6	003.6LR.15530	003.6LR.15537	25,5
1000	600	003.6LS.15628	003.6LS.15635	23,3	003.6LR.15531	003.6LR.15538	27,5
1100	600	003.6LS.15629	003.6LS.15636	25,0	003.6LR.15532	003.6LR.15539	29,5
1200	600	003.6LS.15630	003.6LS.15637	26,7	003.6LR.15533	003.6LR.15540	31,5
1300	600	003.6LS.15631	003.6LS.15638	28,5	003.6LR.15534	003.6LR.15541	33,5
1400	600	003.6LS.15632	003.6LS.15639	30,2	003.6LR.15535	003.6LR.15542	35,5
1500	600	003.6LS.15633	003.6LS.15640	31,9	003.6LR.15536	003.6LR.15543	37,5
900	700	003.7LS.15708	003.7LS.15715	24,2	003.7LR.15578	003.7LR.15585	28,1
1000	700	003.7LS.15709	003.7LS.15716	26,1	003.7LR.15579	003.7LR.15586	30,4
1100	700	003.7LS.15710	003.7LS.15717	28,1	003.7LR.15580	003.7LR.15587	32,7
1200	700	003.7LS.15711	003.7LS.15718	30,1	003.7LR.15581	003.7LR.15588	34,9
1300	700	003.7LS.15712	003.7LS.15719	32,0	003.7LR.15582	003.7LR.15589	37,2
1400	700	003.7LS.15713	003.7LS.15720	34,0	003.7LR.15583	003.7LR.15590	39,4
1500	700	003.7LS.15714	003.7LS.15721	36,0	003.7LR.15584	003.7LR.15591	41,7

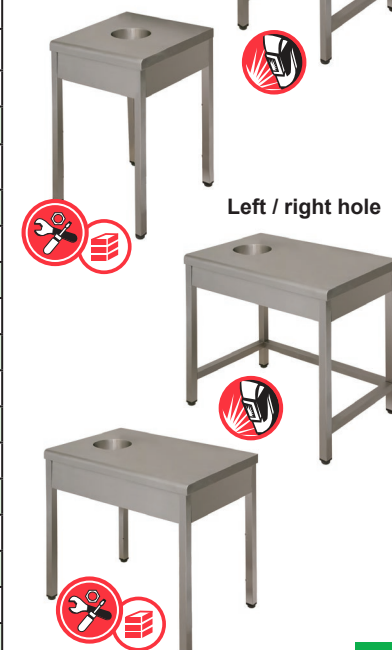

03. TABLES WITH WASTE DISPOSAL HOLE BUSINESS SERIES

- Steel AISI 430
- Welded / demountable construction
- Frame — square tube 40x40 mm
- Can be completed solid or perforated shelf
- It is possible to manufacture products with non-standard sizes

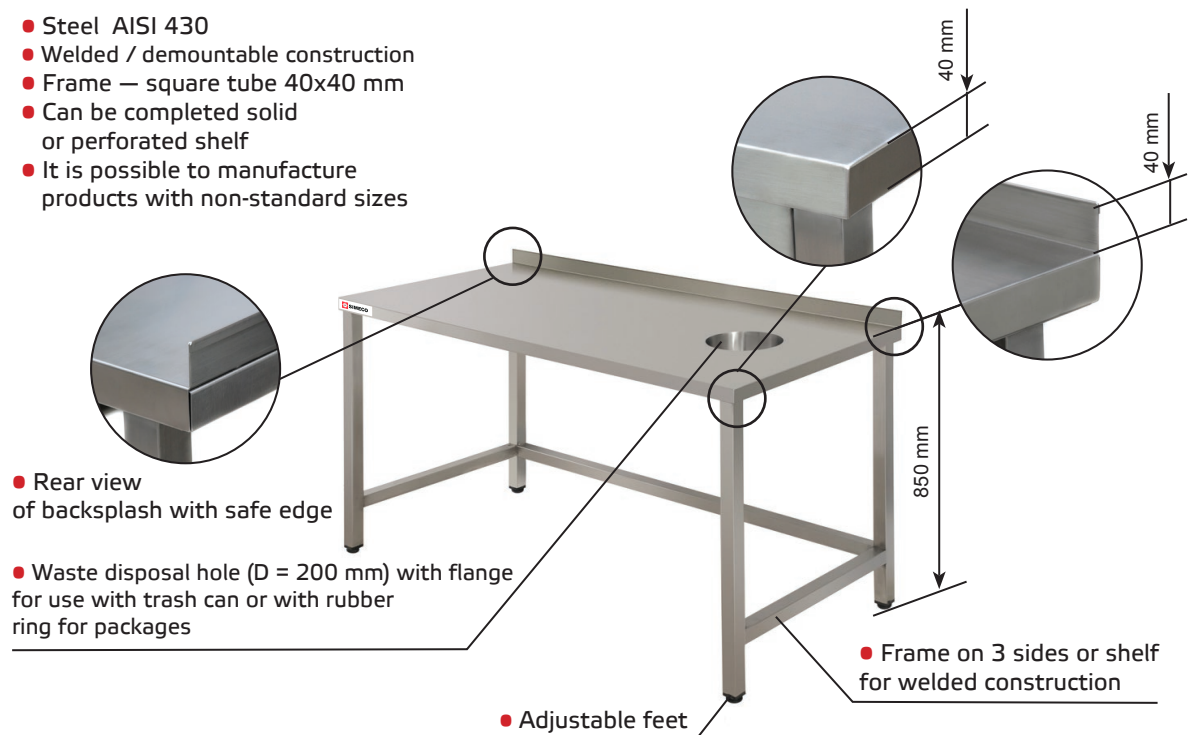

Size of product in the package:



Type of construction	Calculation formula, length x depth x height
	Length + 10 mm X Depth + 10 mm X 895 mm - for tables with backplash Length + 10 mm X Depth + 10 mm X 855 mm - for tables without backplash
	Length + 10 mm X Depth + 10 mm X 195 mm - for tables with backplash Length + 10 mm X Depth + 10 mm X 150 mm - for tables without backplash

TABLE WITH WASTE DISPOSAL HOLE BUSINESS WITH BACKSPASH

Length, mm	Depth, mm	Welded construction		Demountable constr.		Depth, mm	Welded construction		Demountable constr.	
		Code	W, kg	Code	W, kg		Code	W, kg	Code	W, kg
TABLE WITH WASTE DISPOSAL HOLE BUSINESS WITH BACKSPASH (CENTRAL HOLE)										
600	600	003.6ES.04480	11,8	003.6ER.15572	14,3	700	003.7ES.01410	12,8	003.7ER.15621	15,4
700	600	003.6ES.06800	12,5	003.6ER.15573	15,3	700	003.7ES.05632	13,6	003.7ER.15622	16,5
800	600	003.6ES.06759	13,3	003.6ER.15574	16,3	700	003.7ES.15749	14,4	003.7ER.15623	17,5

Central hole



Length, mm	Depth, mm	Welded construction		Demountable construction			
		Code	W, kg	Code	W, kg		
TABLE WITH WASTE DISPOSAL HOLE BUSINESS WITH BACKSPASH (L/R HOLE)							
		левое, L	правое, R	левое, L	правое, R		
900	600	003.6ES.15667	003.6ES.05245	14,0	003.6ER.16341	003.6ER.16342	17,2
1000	600	003.6ES.04891	003.6ES.01781	14,8	003.6ER.05636	003.6ER.16343	18,2
1100	600	003.6ES.15668	003.6ES.15671	15,5	003.6ER.16340	003.6ER.16344	19,2
1200	600	003.6ES.01883	003.6ES.05415	16,3	003.6ER.07307	003.6ER.04672	20,2
1300	600	003.6ES.15669	003.6ES.15672	17,7	003.6ER.16339	003.6ER.16345	21,2
1400	600	003.6ES.15670	003.6ES.15673	18,4	003.6ER.16338	003.6ER.16346	22,2
1500	600	003.6ES.01465	003.6ES.15674	19,2	003.6ER.07462	003.6ER.16347	23,1
900	700	003.7ES.06504	003.7ES.15754	15,3	003.7ER.07531	003.7ER.16357	18,6
1000	700	003.7ES.15750	003.7ES.15755	16,1	003.7ER.16352	003.7ER.16358	19,6
1100	700	003.7ES.15751	003.7ES.15756	16,9	003.7ER.07505	003.7ER.16359	20,7
1200	700	003.7ES.05059	003.7ES.05060	17,7	003.7ER.16353	003.7ER.16360	21,8
1300	700	003.7ES.15752	003.7ES.15757	19,3	003.7ER.16354	003.7ER.16361	22,8
1400	700	003.7ES.15753	003.7ES.15758	20,2	003.7ER.16355	003.7ER.16362	23,9
1500	700	003.7ES.05061	003.7ES.05062	21,0	003.7ER.16356	003.7ER.05842	24,9



The panels are 100 mm high



Left / right hole



TABLE WITH WASTE DISPOSAL HOLE BUSINESS WITHOUT BACKSPASH

Length, mm	Depth, mm	Welded construction		Demountable constr.		Depth, mm	Welded construction		Demountable constr.	
		Code	W, kg	Code	W, kg		Code	W, kg	Code	W, kg
TABLE WITH WASTE DISPOSAL HOLE BUSINESS WITHOUT BACKSPASH (CENTRAL HOLE)										
600	600	003.6ES.16332	11,8	003.6ER.16335	14,3	700	003.7ES.16363	12,8	003.7ER.16349	15,4
700	600	003.6ES.16333	12,5	003.6ER.16336	15,3	700	003.7ES.16364	13,6	003.7ER.16350	16,5
800	600	003.6ES.16334	13,3	003.6ER.16337	16,3	700	003.7ES.16365	14,4	003.7ER.16351	17,5

Central hole



The panels are 100 mm high



Left / right hole



Length, mm	Depth, mm	Welded construction		Demountable construction			
		Code	W, kg	Code	W, kg		
TABLE WITH WASTE DISPOSAL HOLE BUSINESS WITHOUT BACKSPASH (L/R HOLE)							
		left, L	right, R	left, L	right, R		
900	600	003.6ES.15656	003.6ES.15661	13,4	003.6ER.15560	003.6ER.15566	16,6
1000	600	003.6ES.01609	003.6ES.04460	14,1	003.6ER.15561	003.6ER.06826	17,5
1100	600	003.6ES.15657	003.6ES.15662	14,7	003.6ER.15562	003.6ER.15567	18,4
1200	600	003.6ES.15658	003.6ES.15663	15,4	003.6ER.01725	003.6ER.15568	19,3
1300	600	003.6ES.04455	003.6ES.15664	16,8	003.6ER.15563	003.6ER.15569	20,7
1400	600	003.6ES.15659	003.6ES.15665	17,4	003.6ER.15564	003.6ER.15570	21,6
1500	600	003.6ES.15660	003.6ES.15666	18,1	003.6ER.15565	003.6ER.15571	22,5
900	700	003.7ES.15739	003.7ES.15744	14,6	003.7ER.15608	003.7ER.06827	18,0
1000	700	003.7ES.15740	003.7ES.15745	15,4	003.7ER.15609	003.7ER.15615	18,9
1100	700	003.7ES.15741	003.7ES.15746	16,1	003.7ER.15610	003.7ER.15616	19,9
1200	700	003.7ES.04623	003.7ES.01758	16,9	003.7ER.15611	003.7ER.15617	20,9
1300	700	003.7ES.15742	003.7ES.15747	18,4	003.7ER.15612	003.7ER.15618	22,5
1400	700	003.7ES.15743	003.7ES.15748	19,2	003.7ER.15613	003.7ER.15619	23,4
1500	700	003.7ES.05063	003.7ES.06498	19,9	003.7ER.15614	003.7ER.15620	24,4

04. BAKERY WORK TABLES

- Steel AISI 430
- Welded construction
- Frame — square tube 40x40 mm, 40x20 mm
- Without backsplash
- It is possible to manufacture products with non-standard sizes



Size of product in the package:

Type of construction	Calculation formula, length x depth x height
	Length + 10 mm X Depth + 10 mm X 855 mm

BAKERY WORK TABLE WITH BEECH WORKTOP

Length, mm	Depth, mm	Welded construction		Depth, mm	Welded construction		Note
		Code	W, kg		Code	W, kg	
1200	700	004.7US.06421	33,4	800	004.8US.13266	37,0	100 kg
1300	700	004.7US.13259	35,5	800	004.8US.13267	39,2	
1400	700	004.7US.13260	37,5	800	004.8US.04951	41,5	
1500	700	004.7US.05400	39,5	800	004.8US.07209	43,7	
1600	700	004.7US.03051	41,5	800	004.8US.05706	46,0	80 kg
1700	700	004.7US.13261	43,6	800	004.8US.13268	48,2	
1800	700	004.7US.07323	45,6	800	004.8US.13269	50,5	



BAKERY WORK TABLE WITH BEECH WORKTOP WITH SHELF

Length, mm	Depth, mm	Welded construction		Depth, mm	Welded construction		Note
		Code	W, kg		Code	W, kg	
1200	700	004.7US.06122	40,2	800	004.8US.01009	46,0	100 kg
1300	700	004.7US.13262	42,9	800	004.8US.13270	49,1	
1400	700	004.7US.01969	45,6	800	004.8US.13271	52,2	
1500	700	004.7US.04364	48,2	800	004.8US.00995	55,2	
1600	700	004.7US.13263	50,9	800	004.8US.13272	58,3	80 kg
1700	700	004.7US.13264	53,6	800	004.8US.13273	61,4	
1800	700	004.7US.13265	56,2	800	004.8US.03088	64,5	



It is possible to manufacture **BAKERY WORK TABLES WITH BEECH WORKTOP:**

- more than 1800 mm long. In this case, the tables are with 6 legs;
- it is also possible to produce a table include perforated bottom shelf.



BAKERY WORK TABLE WITH GRANITE WORKTOP

Length, mm	Depth, mm	Welded construction		Depth, mm	Welded construction		Note
		Code	W, kg		Code	W, kg	
1200	600	004.6US.13274	52,6	700	004.7US.13280	60,0	100 kg
1300	600	004.6US.13275	56,3	700	004.7US.13270	64,2	
1400	600	004.6US.01969	60,2	700	004.7US.13271	68,4	
1500	600	004.6US.05365	63,7	700	004.7US.13283	72,7	
1600	600	004.6US.13277	67,4	700	004.7US.13284	76,9	80 kg
1700	600	004.6US.13278	71,1	700	004.7US.13285	81,2	
1800	600	004.6US.13279	74,8	700	004.7US.13286	85,5	



BAKERY WORK TABLE WITH GRANITE WORKTOP WITH SHELF

Length, mm	Depth, mm	Welded construction		Note
		Code	W, kg	
1200	700	004.7US.17058	66,4	100 kg
1400	700	004.7US.29466	76,1	
1500	700	004.7US.19108	81,0	
1800	700	004.7US.24771	95,6	80 kg



05. PREPARATION TABLES

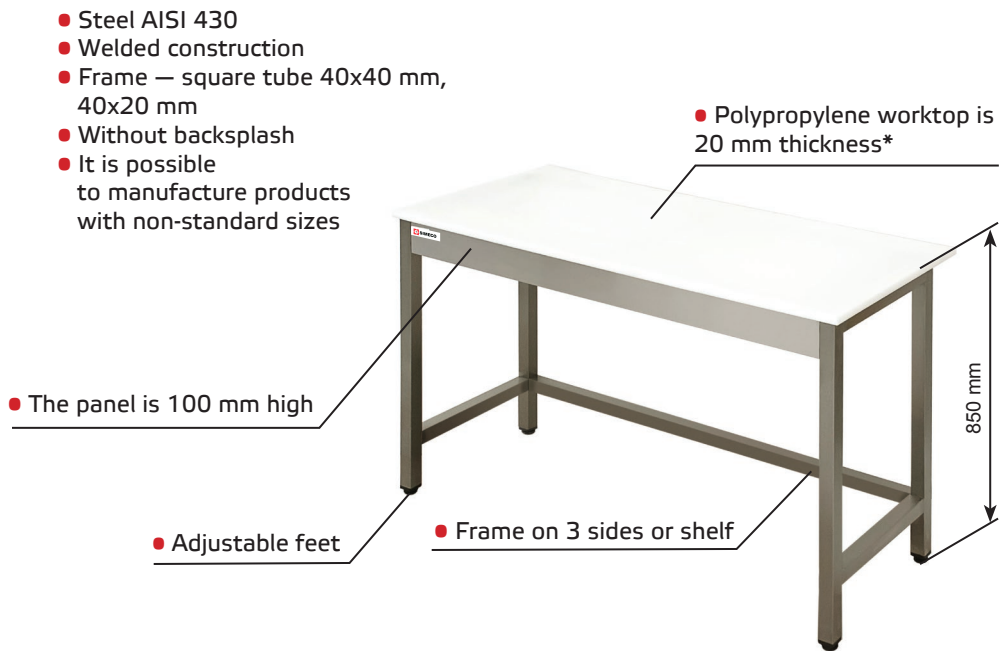

* It is possible to manufacture polypropylene worktops from 30 and 40 mm thickness

Size of product in the package:

Type of construction	Calculation formula, length x depth x height
	Length + 10 mm X Depth + 10 mm X 855 mm

PREPARATION TABLE WITH POLYPROPYLENE WORKTOP

Length, mm	Depth, mm	Welded construction		Depth, mm	Welded construction		Note
		Code	W, kg		Code	W, kg	
1000	600	005.6US.14212	23,8	700	005.7US.04002	26,4	100 kg
1100	600	005.6US.04003	25,3	700	005.7US.14220	28,1	
1200	600	005.6US.14213	26,8	700	005.7US.06910	29,8	
1300	600	005.6US.14214	28,4	700	005.7US.14221	31,6	
1400	600	005.6US.14215	29,9	700	005.7US.14222	33,3	
1500	600	005.6US.14216	31,5	700	005.7US.04060	35,0	80 kg
1600	600	005.6US.14217	33,0	700	005.7US.14223	36,7	
1700	600	005.6US.14218	34,5	700	005.7US.14224	38,4	
1800	600	005.6US.14219	36,1	700	005.7US.14225	40,2	



PREPARATION TABLE WITH POLYPROPYLENE WORKTOP WITH SHELF

Length, mm	Depth, mm	Welded construction		Depth, mm	Welded construction		Note
		Code	W, kg		Code	W, kg	
1000	600	005.6US.14226	28,6	700	005.7US.05978	31,9	100 kg
1100	600	005.6US.14227	30,7	700	005.7US.14235	34,3	
1200	600	005.6US.14228	32,8	700	005.7US.06313	36,6	
1300	600	005.6US.14229	34,9	700	005.7US.14236	39,0	
1400	600	005.6US.14230	37,0	700	005.7US.04609	41,4	
1500	600	005.6US.14231	39,1	700	005.7US.04828	43,7	80 kg
1600	600	005.6US.14232	41,2	700	005.7US.14237	46,1	
1700	600	005.6US.14233	43,3	700	005.7US.14238	48,4	
1800	600	005.6US.14234	45,4	700	005.7US.14239	50,8	



It is possible to manufacture **PREPARATION TABLES:**

- more than 1800 mm long. In this case, the tables are with 6 legs;
- it is also possible to produce a table include perforated bottom shelf.

PREPARATION TABLE FOR BUTCHER'S WITH POLYPROPYLENE WORKTOP WITH HOLES

These tables are used by hypermarkets and catering for meat cutting and boning.

Length, mm	Depth, mm	Code	W, kg
1720	850	905.0US.17488	71
1720	1700	905.0US.22225	150

* Drawers 600x400 mm are not included in the package

• Polypropylene worktop is 30 mm thickness

• Polypropylene worktop is 20 mm thickness

• 4 meat sorting holes



• 8 meat sorting holes

• Tray for a drawers*

You may interested in **SINK UNIT WITH POLYPROPYLENE BOARDS** at page 49.

06. TABLES FOR DISHWASHING MACHINE

INPUT TABLES FOR DISHWASHING MACHINE



Length, mm	Depth, mm	Height, mm	Code	W, kg	Note
TABLE FOR DISHWASHING MACHINE LEFT/RIGHT					
1200	750	870	006.7US.06512	20,1	Left entry. The bowl with 400x400x280mm is on the right. Waste disposal hole is on the left. It is right mount.
1200	750	870	006.7US.06354	20,1	Right entry. The bowl with 400x400x280mm is on the left. Waste disposal hole on the right. It is left mount.
1200	750	870	106.7US.39007	20,1	Left entry. The bowl with 500x400x300mm is on the right. Waste disposal hole is on the left. It is right mount.
1200	750	870	106.7US.39008	20,1	Right entry. The bowl with 500x400x300mm is on the left. Waste disposal hole on the right. It is left mount.

Size of product in the package:
1210 mm X 760 mm X 1075 mm

OUTPUT TABLES FOR DISHWASHING MACHINE

- The worktop is made of steel AISI 304
- Steel AISI 430
- Welded construction
- Frame — square tube 40x40 mm
- Left / right mount
- 5 levels of guides under cassettes 500x500x100 mm / 2x5 levels under cassette guides 500x500x100 mm

• The backsplash is 40 mm height

• There are recess in the worktop for tableware cassettes

• Perimeter frame

• Adjustable feet



Length, mm	Depth, mm	Height, mm	Code LEFT (right mount)	W, kg	Code RIGHT (left mount)	W, kg	Note
TABLE FOR DISHWASHING MACHINE LEFT/RIGHT							
600	750	870	006.7US.13288	9,6	006.7US.13291	9,6	Without guides
600	750	870	006.7US.13287	11,6	006.7US.06513	11,6	5 levels of guides under cassettes 500x500x100 mm
1200	750	870	006.7US.13289	11,7	006.7US.13292	11,7	Without guides
1200	750	870	006.7US.06578	18,4	006.7US.13290	18,4	2x5 levels under cassette guides 500x500x100 mm

Size of product in the package:

For a length of 600 mm - 610 mm X 760 mm X 1015 mm

For a length of 1200 mm - 1210 mm X 760 mm X 1015 mm

OUTPUT TABLES FOR DISHWASHING MACHINE

- The worktop is made of steel AISI 304 with 1,5 mm thickness
- Welded construction
- Frame — square tube 40x40 mm
- Left / right mount
- Drain hole

• The backsplash is 200 mm height

• Adjustable feet

• Frame on 3 sides

• There are rollers on the worktop for moving the tableware cassettes

• Inclined worktop with recess



Length, mm	Depth, mm	Height, mm	Code	W, kg	Note
TABLE FOR DISHWASHING MACHINE LEFT/RIGHT WITH LOADING CONVEYOR					
1000	700	870	906.7US.26598	45	LEFT (right mount)
1000	700	870	906.7US.27288	45	RIGHT (left mount)

Size of product in the package:

1010 mm X 710 mm X 1075 mm

02. CUPBOARDS LUX SERIES

- Steel AISI 304
- Welded construction
- Execution versions: without doors; with swing doors; with sliding doors; with drawers
- Frame — square tube 40x40 mm
- It is possible to manufacture products with non-standard sizes

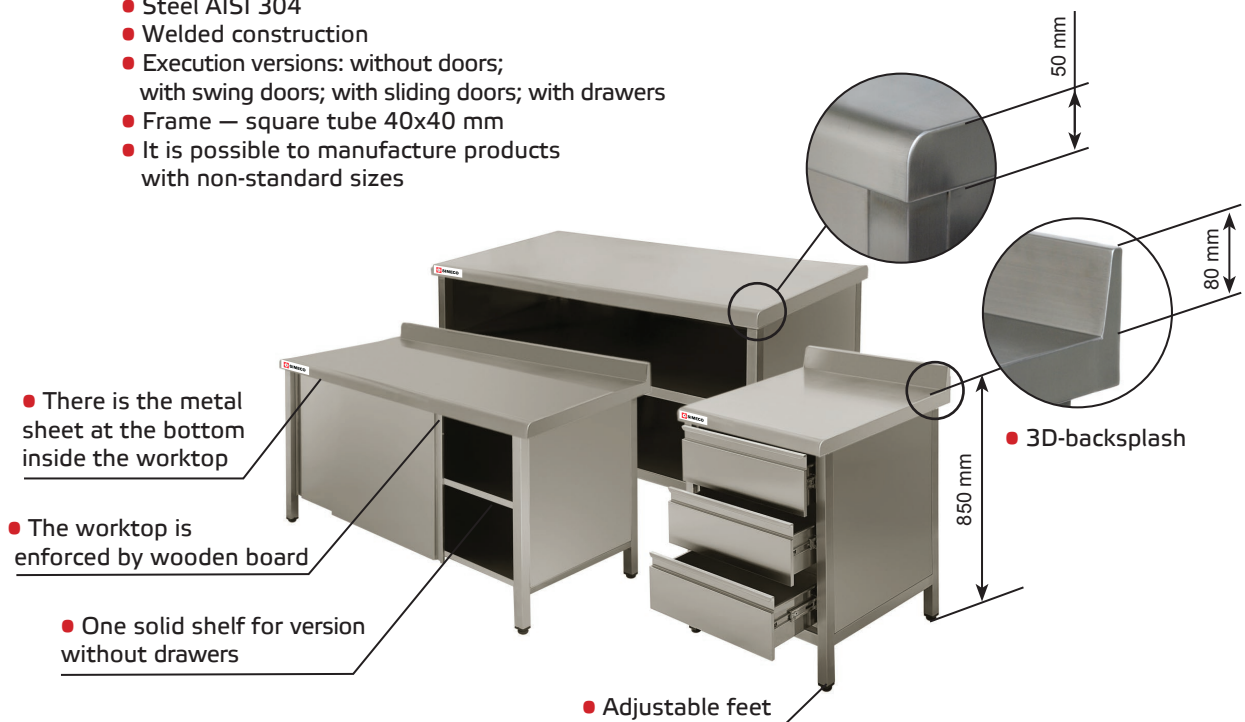

Size of product in the package:

Type of construction	Calculation formula, length x depth x height
	Length + 10 mm X Depth + 10 mm X 935 mm - for cupboards with backslash Length + 10 mm X Depth + 10 mm X 855 mm - for cupboards without backslash

CUPBOARD LUX WITH BACKSPLASH WITHOUT DOORS

Length, mm	Depth, mm	Welded construction		Depth, mm	Welded construction		Note
		Code	W, kgr		Code	W, kgr	
600	600	002.6LS.13324	30,3	700	002.7LS.13511	33,7	100 kg
700	600	002.6LS.13325	33,7	700	002.7LS.13512	37,6	
800	600	002.6LS.13326	37,2	700	002.7LS.13513	41,4	
900	600	002.6LS.13327	40,6	700	002.7LS.13514	45,3	
1000	600	002.6LS.13328	44,1	700	002.7LS.13515	49,1	
1100	600	002.6LS.13329	47,5	700	002.7LS.13516	52,9	
1200	600	002.6LS.13330	51,0	700	002.7LS.13517	56,8	
1300	600	002.6LS.13331	54,4	700	002.7LS.13518	60,6	
1400	600	002.6LS.13332	57,9	700	002.7LS.13519	64,4	
1500	600	002.6LS.13333	61,3	700	002.7LS.13520	68,3	
1600	600	002.6LS.13334	64,8	700	002.7LS.13521	72,1	80 kg
1700	600	002.6LS.13335	68,2	700	002.7LS.13522	76,0	
1800	600	002.6LS.13336	71,7	700	002.7LS.13523	79,8	



CUPBOARD LUX WITH BACKSPLASH WITH SWING DOORS



Length, mm	Depth, mm	Welded construction		Depth, mm	Welded construction		Note
		Code	W, kgr		Code	W, kgr	
600	600	002.6LS.01851	35,1	700	002.7LS.13532	38,7	100 kg
700	600	002.6LS.13343	39,6	700	002.7LS.13533	43,6	
800	600	002.6LS.13344	44,2	700	002.7LS.01887	48,6	
900	600	002.6LS.13345	48,6	700	002.7LS.13534	53,4	
1000	600	002.6LS.13346	53,1	700	002.7LS.13535	58,3	
1100	600	002.6LS.13347	57,5	700	002.7LS.13536	63,1	
1200	600	002.6LS.13348	61,9	700	002.7LS.13537	67,9	
1300	600	002.6LS.13349	66,4	700	002.7LS.13538	72,8	
1400	600	002.6LS.13350	70,8	700	002.7LS.13539	77,6	
1500	600	002.6LS.13351	77,7	700	002.7LS.13540	85,4	
1600	600	002.6LS.13352	82,1	700	002.7LS.13541	90,2	80 kg
1700	600	002.6LS.13353	86,6	700	002.7LS.13542	95,1	
1800	600	002.6LS.13354	91,0	700	002.7LS.13543	99,9	



- It is possible to manufacture **CUPBOARDS LUX** series:
- more than 1800 mm long. In this case, the cupboards are with 6 legs and in version with swing doors — 4 doors
 - also cupboards on request can be equipped with locks.

CUPBOARD LUX WITH BACKSPLASH WITH SLIDING DOORS



Length, mm	Depth, mm	Welded construction		Depth, mm	Welded construction		Note
		Code	W, kgr		Code	W, kgr	
1000	600	002.6LS.13339	57,2	700	002.7LS.07185	62,4	 100 kg
1100	600	002.6LS.06162	62,0	700	002.7LS.13526	67,6	
1200	600	002.6LS.04773	66,8	700	002.7LS.05449	72,8	
1300	600	002.6LS.13340	71,5	700	002.7LS.13527	78,0	
1400	600	002.6LS.05661	76,3	700	002.7LS.13528	83,2	
1500	600	002.6LS.00863	81,1	700	002.7LS.06738	88,3	
1600	600	002.6LS.13341	85,9	700	002.7LS.13529	93,5	 80 kg
1700	600	002.6LS.13342	90,7	700	002.7LS.13530	98,7	
1800	600	002.6LS.04753	95,5	700	002.7LS.13531	103,9	



CUPBOARD LUX WITH BACKSPLASH WITH DRAWERS





Length, mm	Depth, mm	Welded construction		Depth, mm	Welded construction		Note
		Code	W, kgr		Code	W, kgr	
400	600	002.6LS.17017	41,1	700	002.7LS.17028	43,8	With 3 drawers. Max. box load 36 kg
500	600	002.6LS.17016	44,5	700	002.7LS.17027	47,6	
600	600	002.6LS.13337	48,0	700	002.7LS.13524	51,4	
700	600	002.6LS.13338	51,4	700	002.7LS.13525	55,3	

CUPBOARD LUX WITHOUT BACKSPLASH WITHOUT DOORS





Length, mm	Depth, mm	Welded construction		Depth, mm	Welded construction		Note
		Code	W, kgr		Code	W, kgr	
600	600	002.6LS.13293	30,1	700	002.7LS.13476	33,7	 100 kg
700	600	002.6LS.13294	33,4	700	002.7LS.13477	37,5	
800	600	002.6LS.13295	36,8	700	002.7LS.13478	41,2	
900	600	002.6LS.13296	40,1	700	002.7LS.13479	45,0	
1000	600	002.6LS.13297	43,5	700	002.7LS.13480	48,7	
1100	600	002.6LS.13298	46,8	700	002.7LS.13481	52,5	
1200	600	002.6LS.13299	50,2	700	002.7LS.13482	56,2	
1300	600	002.6LS.13300	53,5	700	002.7LS.13483	60,0	
1400	600	002.6LS.13301	56,9	700	002.7LS.13484	63,7	
1500	600	002.6LS.01045	60,2	700	002.7LS.13485	67,5	
1600	600	002.6LS.13302	63,5	700	002.7LS.13486	71,3	 80 kg
1700	600	002.6LS.13303	66,9	700	002.7LS.13487	75,0	
1800	600	002.6LS.13304	70,2	700	002.7LS.13488	78,8	

CUPBOARD LUX WITHOUT BACKSPLASH WITH SWING DOORS

Length, mm	Depth, mm	Welded construction		Depth, mm	Welded construction		Note
		Code	W, kgr		Code	W, kgr	
600	600	002.6LS.13312	35,6	700	002.7LS.13499	39,2	1 swing door  100 kg
700	600	002.6LS.13313	40,0	700	002.7LS.13500	44,1	
800	600	002.6LS.13314	44,6	700	002.7LS.13501	49,1	
900	600	002.6LS.13315	49,0	700	002.7LS.13502	53,9	
1000	600	002.6LS.04772	53,5	700	002.7LS.01886	58,8	
1100	600	002.6LS.13316	57,9	700	002.7LS.13503	63,6	
1200	600	002.6LS.13317	62,3	700	002.7LS.13504	68,4	
1300	600	002.6LS.13318	66,8	700	002.7LS.13505	73,3	
1400	600	002.6LS.13319	71,2	700	002.7LS.13506	78,1	
1500	600	002.6LS.13320	69,5	700	002.7LS.13507	76,1	
1600	600	002.6LS.13321	73,3	700	002.7LS.13508	80,2	3 swing doors  80 kg
1700	600	002.6LS.13322	77,2	700	002.7LS.13509	84,4	
1800	600	002.6LS.13323	81,0	700	002.7LS.13510	88,6	



CUPBOARD LUX WITHOUT BACKSPLASH WITH SLIDING DOORS

Length, mm	Depth, mm	Welded construction		Depth, mm	Welded construction		Note
		Code	W, kgr		Code	W, kgr	
1000	600	002.6LS.01041	56,8	700	002.7LS.13490	62,0	 100 kg
1100	600	002.6LS.13306	61,5	700	002.7LS.13491	67,1	
1200	600	002.6LS.01042	66,2	700	002.7LS.13492	72,2	
1300	600	002.6LS.13307	70,9	700	002.7LS.13493	77,3	
1400	600	002.6LS.13308	75,6	700	002.7LS.13494	82,4	
1500	600	002.6LS.13309	80,3	700	002.7LS.13495	87,5	
1600	600	002.6LS.13310	85,0	700	002.7LS.13496	92,6	 80 kg
1700	600	002.6LS.13311	89,6	700	002.7LS.13497	97,7	
1800	600	002.6LS.01043	94,3	700	002.7LS.16124	102,8	



CUPBOARD LUX WITHOUT BACKSPLASH WITH DRAWERS

Length, mm	Depth, mm	Welded construction		Depth, mm	Welded construction		Note
		Code	W, kgr		Code	W, kgr	
400	600	002.6LS.17015	41,1	700	002.7LS.17026	43,9	With 3 drawers. Max. box load 36 kg
500	600	002.6LS.17014	44,4	700	002.7LS.17025	47,7	
600	600	002.6LS.05682	47,8	700	002.7LS.13489	51,4	
700	600	002.6LS.13305	51,1	700	002.7LS.05453	55,2	



02. CUPBOARDS BUSINESS SERIES

- Steel AISI 430
- Welded construction
- Execution versions: without doors; with swing doors; with sliding doors; with drawers
- Frame — square tube 40x40 mm
- It is possible to manufacture products with non-standard sizes

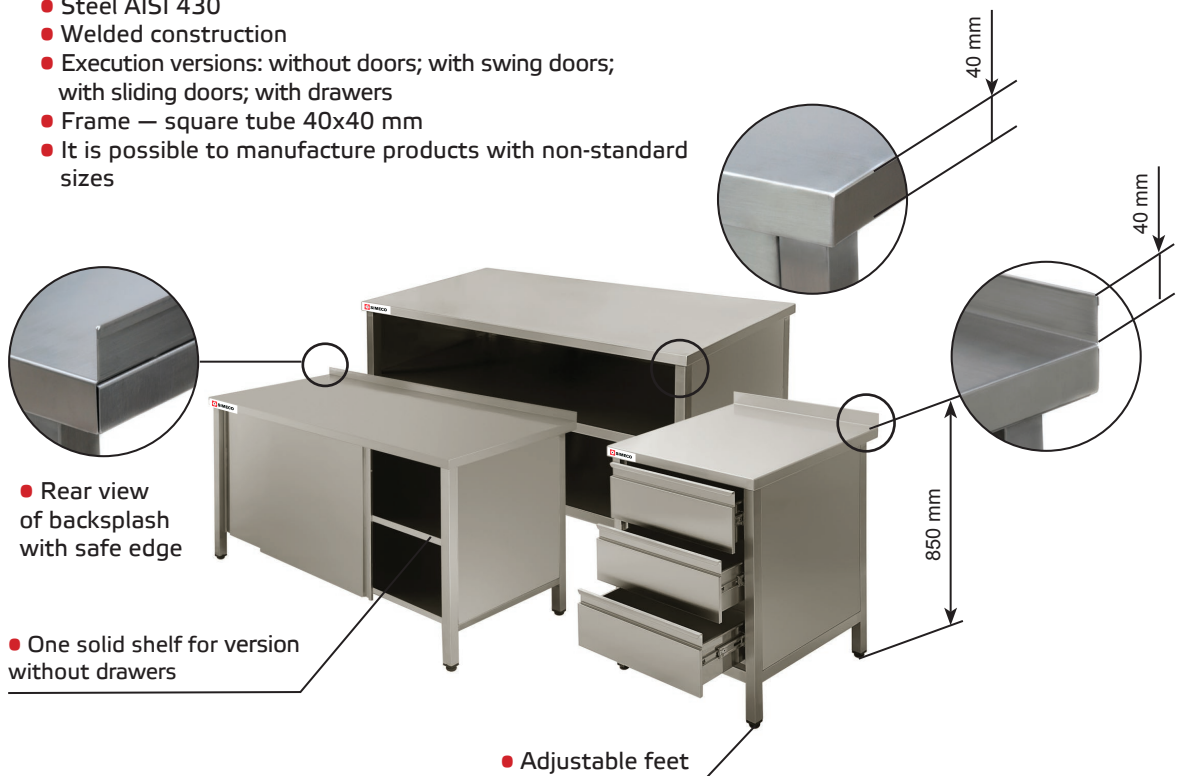

Size of product in the package:

Type of construction	Calculation formula, length x depth x height
	Length + 10 mm X Depth + 10 mm X 895 mm - for cupboards with backplash Length + 10 mm X Depth + 10 mm X 855 mm - for cupboards without backplash

CUPBOARD BUSINESS WITH BACKSPLASH WITHOUT DOORS

Length, mm	Depth, mm	Welded construction		Depth, mm	Welded construction		Note
		Code	W, kgr		Code	W, kgr	
600	600	002.6ES.13384	23,7	700	002.7ES.13572	26,4	100 kg
700	600	002.6ES.13385	26,2	700	002.7ES.13573	29,0	
800	600	002.6ES.13386	28,6	700	002.7ES.06508	31,7	
900	600	002.6ES.13387	31,1	700	002.7ES.05220	34,4	
1000	600	002.6ES.06511	33,5	700	002.7ES.13574	37,1	
1100	600	002.6ES.13388	36,0	700	002.7ES.13575	39,8	
1200	600	002.6ES.04733	38,4	700	002.7ES.05032	42,5	
1300	600	002.6ES.13389	40,9	700	002.7ES.13576	45,1	
1400	600	002.6ES.13390	43,3	700	002.7ES.13577	47,8	
1500	600	002.6ES.13391	45,8	700	002.7ES.05221	50,5	
1600	600	002.6ES.13392	48,2	700	002.7ES.13578	53,2	
1700	600	002.6ES.13393	50,7	700	002.7ES.13579	55,9	
1800	600	002.6ES.13394	53,1	700	002.7ES.13580	58,6	



CUPBOARD BUSINESS WITH BACKSPLASH WITH SWING DOORS

Length, mm	Depth, mm	Welded construction		Depth, mm	Welded construction		Note
		Code	W, kgr		Code	W, kgr	
600	600	002.6ES.04714	29,2	700	002.7ES.06100	31,8	100 kg
700	600	002.6ES.13401	32,8	700	002.7ES.13588	35,6	
800	600	002.6ES.13402	36,5	700	002.7ES.13589	39,5	
900	600	002.6ES.00861	40,0	700	002.7ES.04932	43,3	
1000	600	002.6ES.01693	43,5	700	002.7ES.13590	47,1	
1100	600	002.6ES.13403	47,1	700	002.7ES.13591	50,8	
1200	600	002.6ES.13404	50,6	700	002.7ES.13592	54,6	
1300	600	002.6ES.13405	54,1	700	002.7ES.13593	58,4	
1400	600	002.6ES.13406	57,6	700	002.7ES.05034	62,1	
1500	600	002.6ES.13407	63,7	700	002.7ES.13594	68,9	
1600	600	002.6ES.13408	67,2	700	002.7ES.13595	72,7	
1700	600	002.6ES.13409	70,7	700	002.7ES.13596	76,4	
1800	600	002.6ES.13410	74,3	700	002.7ES.13597	80,2	



- It is possible to manufacture **CUPBOARDS BUSINESS** series:
- more than 1800 mm long. In this case, the tables are with 6 legs and in version with swing doors — 4 doors
 - also tables on request can be equipped with locks.

CUPBOARD BUSINESS WITH BACKSPLASH WITH SLIDING DOORS



Length, mm	Depth, mm	Welded construction		Depth, mm	Welded construction		Note
		Code	W, kgr		Code	W, kgr	
1000	600	002.6ES.04970	47,5	700	002.7ES.06099	51,0	100 kg
1100	600	002.6ES.13397	51,3	700	002.7ES.13583	55,1	
1200	600	002.6ES.01673	55,2	700	002.7ES.06787	59,2	
1300	600	002.6ES.13398	59,0	700	002.7ES.13584	63,3	
1400	600	002.6ES.13399	62,9	700	002.7ES.01470	67,4	
1500	600	002.6ES.04774	66,7	700	002.7ES.04394	71,5	
1600	600	002.6ES.06180	70,6	700	002.7ES.13585	75,5	80 kg
1700	600	002.6ES.13400	74,4	700	002.7ES.07490	79,6	
1800	600	002.6ES.04750	78,3	700	002.7ES.13587	83,7	

CUPBOARD BUSINESS WITHOUT BACKSPLASH WITHOUT DOORS



Length, mm	Depth, mm	Welded construction		Depth, mm	Welded construction		Note
		Code	W, kgr		Code	W, kgr	
400	600	002.6ES.05121	27,0	700	002.7ES.16989	30,1	With 3 drawers. Max. box load 36 kg
500	600	002.6ES.17013	31,5	700	002.7ES.17024	35,0	
600	600	002.6ES.13395	36,0	700	002.7ES.05033	39,8	
700	600	002.6ES.13396	40,5	700	002.7ES.13582	44,7	

CUPBOARD BUSINESS WITHOUT BACKSPLASH WITHOUT DOORS



Length, mm	Depth, mm	Welded construction		Depth, mm	Welded construction		Note
		Code	W, kgr		Code	W, kgr	
600	600	002.6ES.13355	24,4	700	002.7ES.13544	27,0	100 kg
700	600	002.6ES.13356	26,8	700	002.7ES.13545	29,7	
800	600	002.6ES.13357	29,3	700	002.7ES.13546	32,4	
900	600	002.6ES.13358	31,8	700	002.7ES.13547	35,1	
1000	600	002.6ES.13359	34,3	700	002.7ES.06106	37,8	
1100	600	002.6ES.13360	36,8	700	002.7ES.13548	40,6	
1200	600	002.6ES.13361	39,3	700	002.7ES.05224	43,3	
1300	600	002.6ES.13362	41,7	700	002.7ES.13549	46,0	
1400	600	002.6ES.13363	44,2	700	002.7ES.13550	48,7	
1500	600	002.6ES.04715	46,7	700	002.7ES.13551	51,4	
1600	600	002.6ES.13364	49,2	700	002.7ES.13552	54,2	80 kg
1700	600	002.6ES.13365	51,7	700	002.7ES.13553	56,9	
1800	600	002.6ES.13366	54,2	700	002.7ES.13554	59,6	

CUPBOARD BUSINESS WITHOUT BACKSPLASH WITH SWING DOORS

Length, mm	Depth, mm	Welded construction		Depth, mm	Welded construction		Note
		Code	W, kgr		Code	W, kgr	
600	600	002.6ES.13373	29,8	700	002.7ES.13561	47,8	1 swing door 100 kg
700	600	002.6ES.13374	33,4	700	002.7ES.13562	51,6	
800	600	002.6ES.13375	37,1	700	002.7ES.13563	55,4	
900	600	002.6ES.00851	40,7	700	002.7ES.13564	59,2	
1000	600	002.6ES.13376	44,3	700	002.7ES.13565	63,0	
1100	600	002.6ES.13377	47,8	700	002.7ES.13566	70,0	
1200	600	002.6ES.13378	51,4	700	002.7ES.05523	73,8	
1300	600	002.6ES.13379	55,0	700	002.7ES.13567	77,6	
1400	600	002.6ES.13380	58,5	700	002.7ES.05528	81,4	
1500	600	002.6ES.01164	64,8	700	002.7ES.13568	32,5	
1600	600	002.6ES.13381	68,3	700	002.7ES.13569	36,3	3 swing doors 80 kg
1700	600	002.6ES.13382	71,9	700	002.7ES.13570	40,2	
1800	600	002.6ES.13383	75,5	700	002.7ES.13571	44,0	



CUPBOARD BUSINESS WITHOUT BACKSPLASH WITH SLIDING DOORS

Length, mm	Depth, mm	Welded construction		Depth, mm	Welded construction		Note
		Code	W, kgr		Code	W, kgr	
1000	600	002.6ES.13368	47,5	700	002.7ES.13556	51,1	100 kg
1100	600	002.6ES.13369	51,3	700	002.7ES.13557	55,1	
1200	600	002.6ES.04796	55,2	700	002.7ES.04797	59,2	
1300	600	002.6ES.13370	59,0	700	002.7ES.13558	63,2	
1400	600	002.6ES.04029	62,8	700	002.7ES.13559	67,3	
1500	600	002.6ES.04798	66,6	700	002.7ES.04617	71,3	
1600	600	002.6ES.13371	70,4	700	002.7ES.06115	75,4	80 kg
1700	600	002.6ES.13372	74,3	700	002.7ES.13560	79,5	
1800	600	002.6ES.04385	78,1	700	002.7ES.05695	83,5	



CUPBOARD BUSINESS WITHOUT BACKSPLASH WITH DRAWERS

Length, mm	Depth, mm	Welded construction		Depth, mm	Welded construction		Note
		Code	W, kgr		Code	W, kgr	
400	600	002.6ES.17012	27,1	700	002.7ES.17023	30,5	With 3 drawers. Max. box load 36 kg
500	600	002.6ES.17011	31,7	700	002.7ES.17022	35,4	
600	600	002.6ES.16409	36,3	700	002.7ES.06225	40,3	
700	600	002.6ES.13367	40,9	700	002.7ES.13555	45,2	



They trust us:



CONTACTS

Address: Russia, Moscow.
Tel./Fax: +7 (495) 925-76-76
E-mail: info@simeco.ru
www.simeco.ru

